

iek

TITAN 5

Инструкция по монтажу щитов

[Перейти к продукции](#)

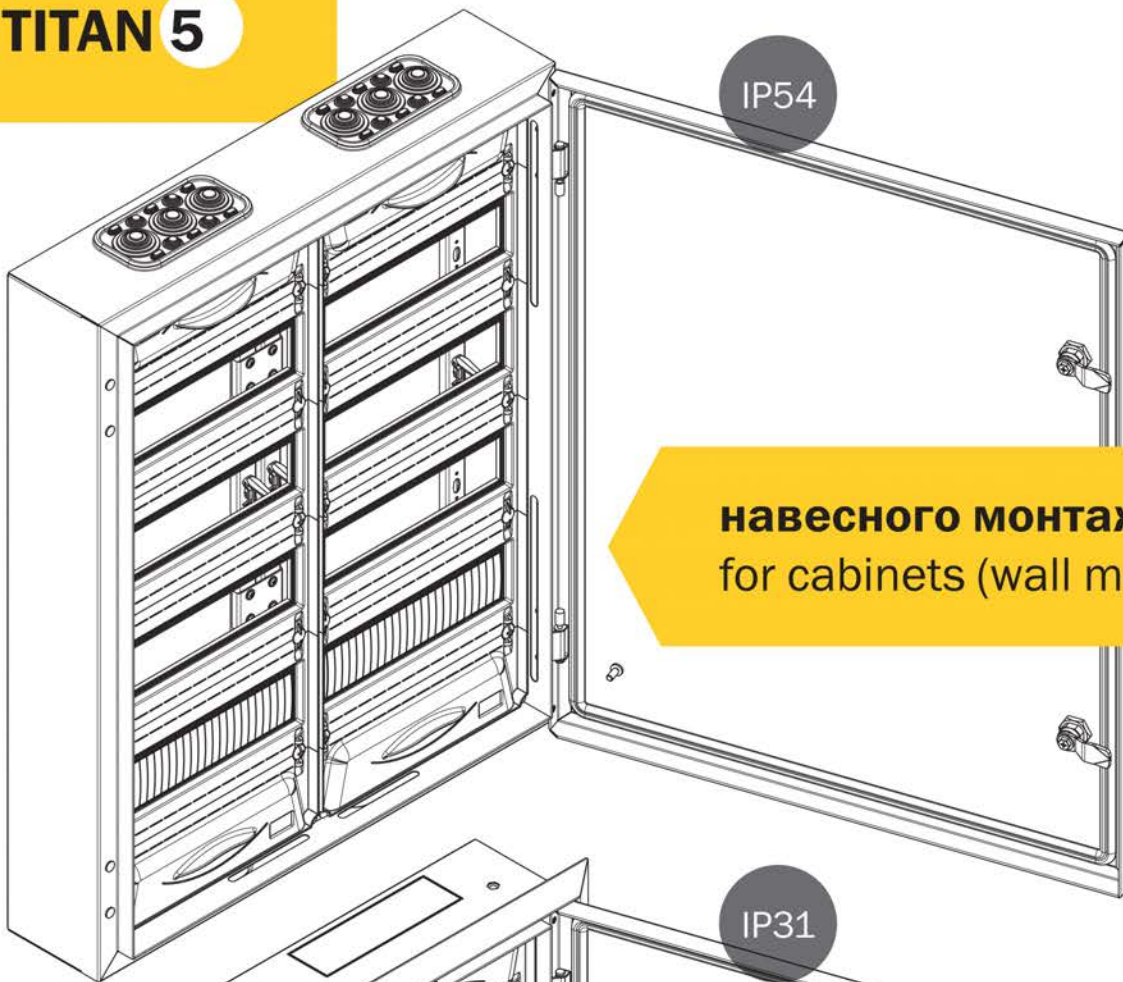

ЩРн

1

Схема сборки шкафа Cabinet mounting scheme

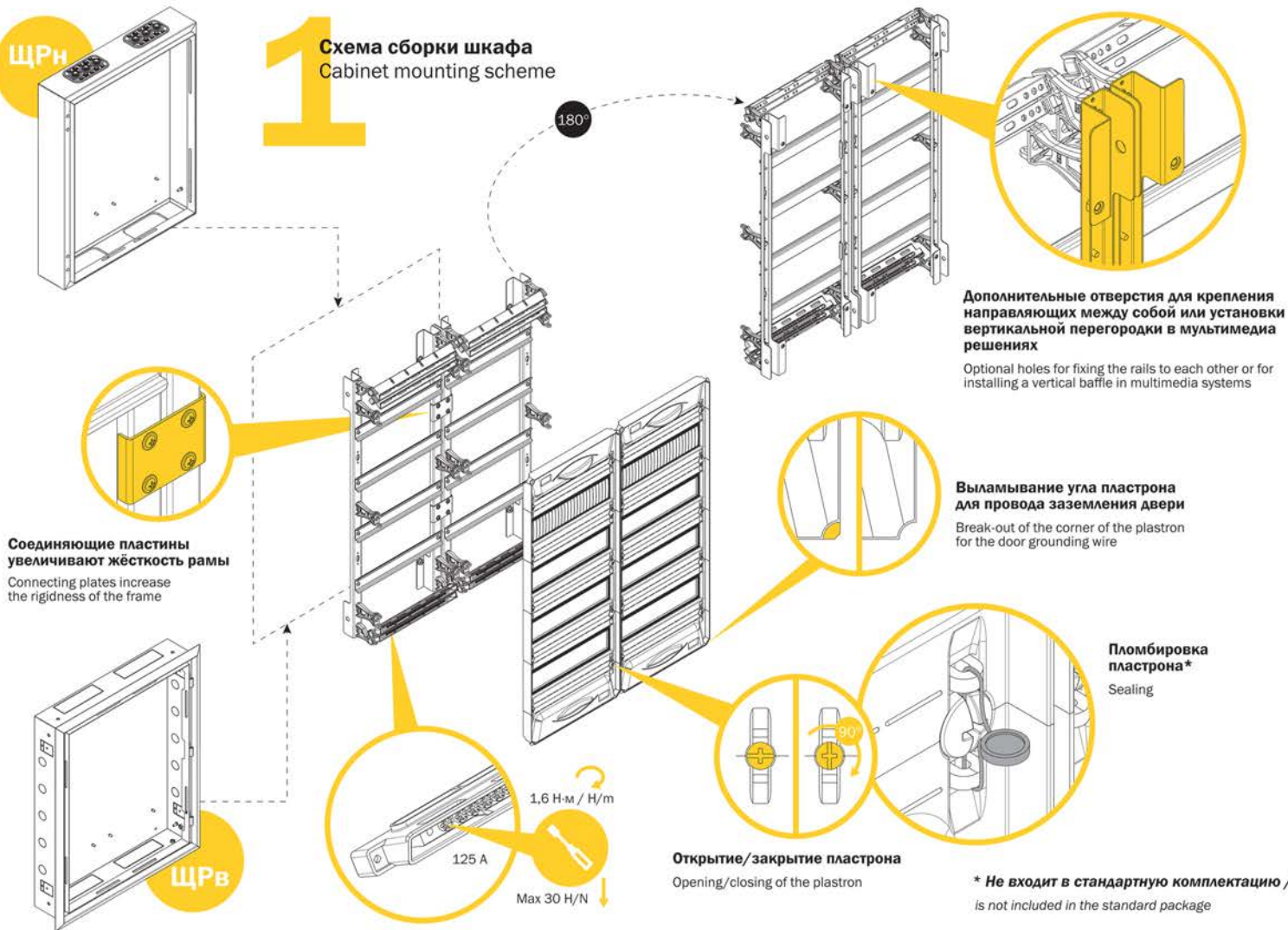

2

Заземление дверей Door grounding

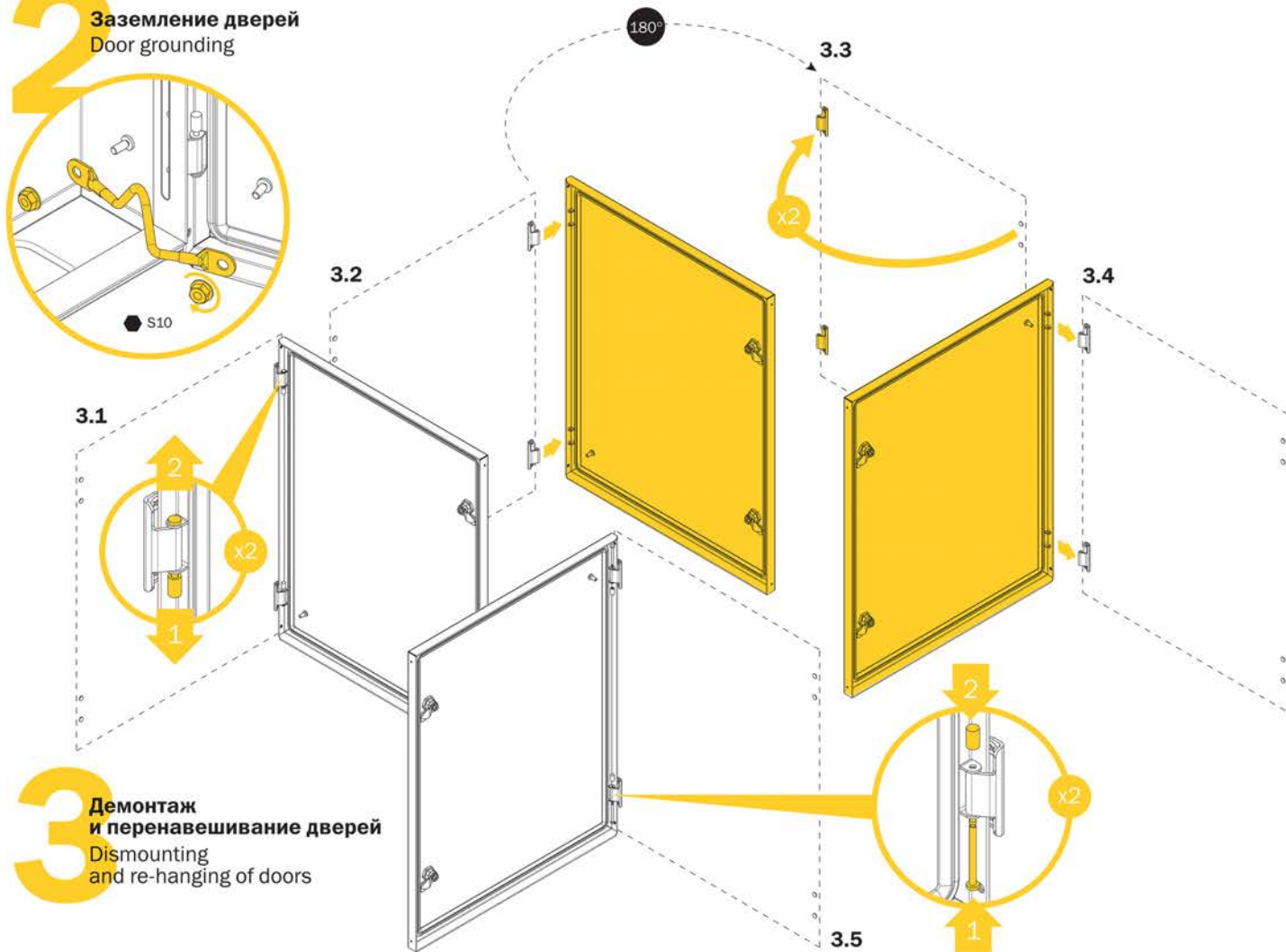
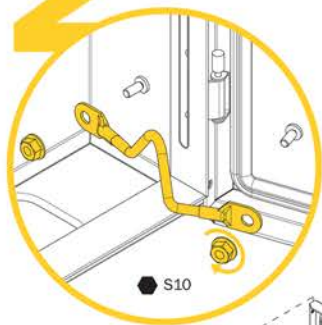

3

Демонтаж и перенавешивание дверей Dismounting and re-hanging of doors



4

Размеры ниши в мм для встраиваемых шкафов ЩРВ Recess dimensions for flush-mounted cabinets

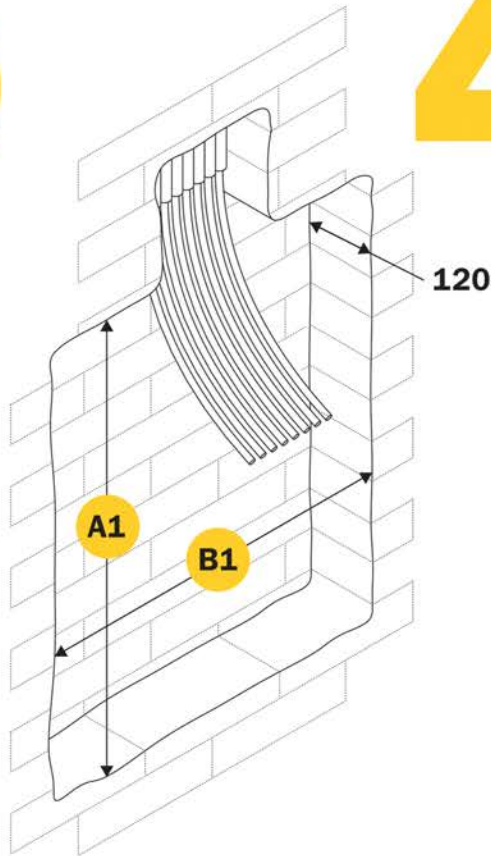

		A1	B1
12	(1×12)	340	325
24	(1×24)	465	325
36	(1×36)	590	325
48	(1×48)	715	325
60	(1×60)	840	325
72	(1×72)	965	325
84	(1×84)	1090	325
48	(2×24)	465	585
72	(2×36)	590	585
96	(2×48)	715	585
120	(2×60)	840	585
144	(2×72)	965	585
168	(2×84)	1090	585
108	(3×36)	590	845
144	(3×48)	715	845
180	(3×60)	840	845
216	(3×72)	965	845
252	(3×84)	1090	845

5

Установка основания в нишу Installing the base in a recess

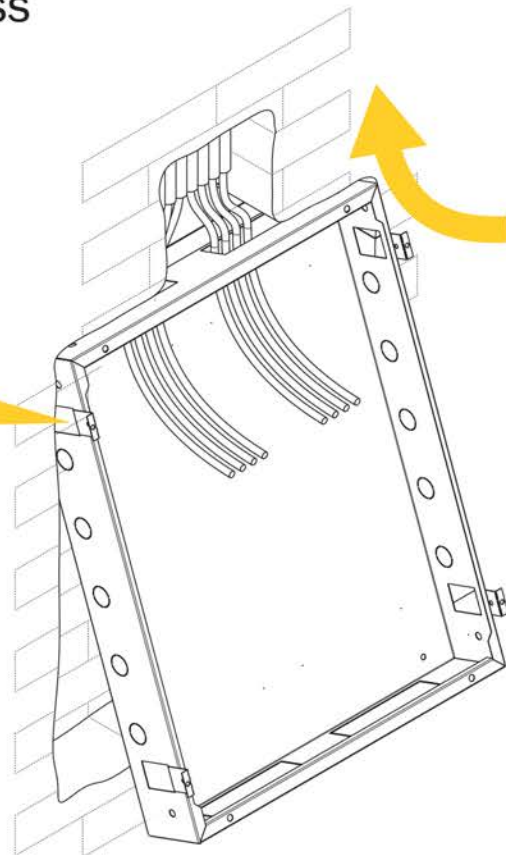
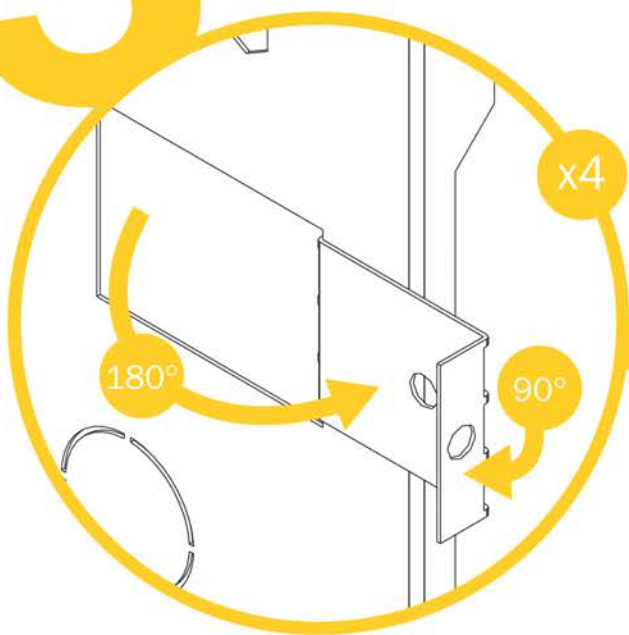

6

Дополнительное выравнивание основания при помощи болтов
Optional alignment of the base with screws

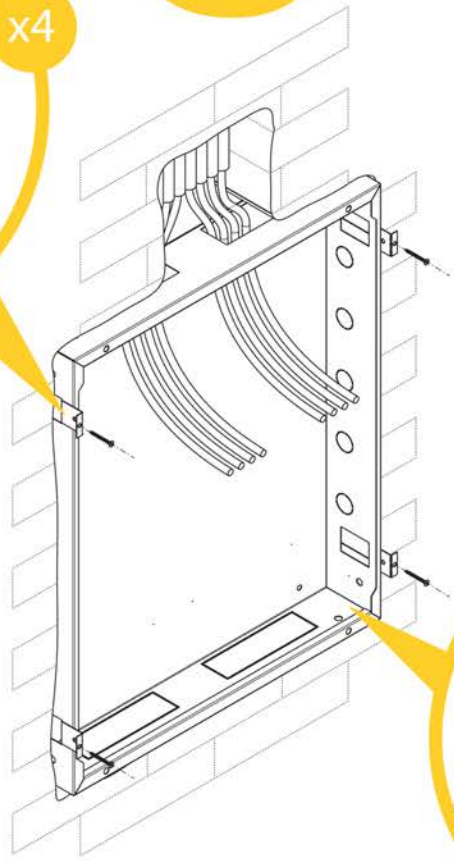
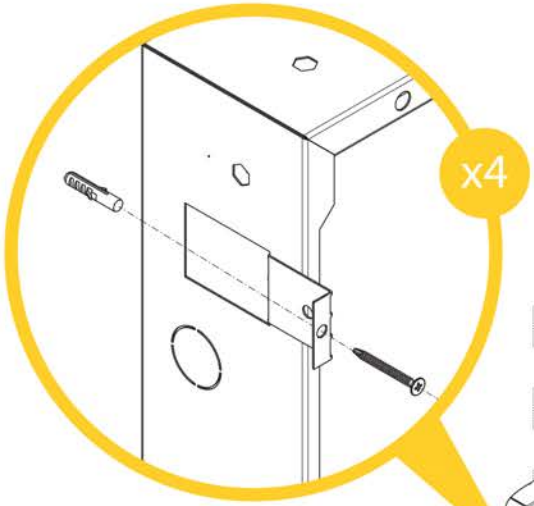

Отверстия для выравнивания основания по вертикали и по горизонтали

Holes for vertical and horizontal alignment of the base

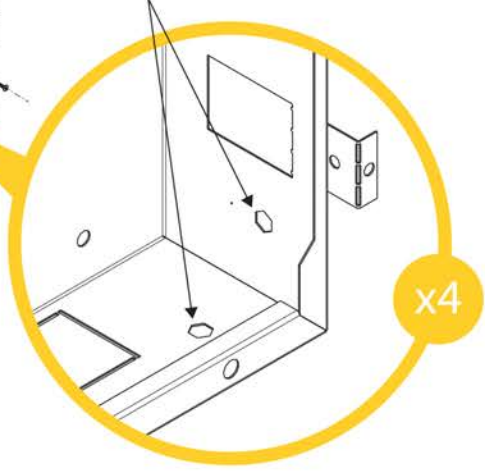

7

Установка лицевой рамки с возможностью выравнивания по горизонту и глубине

Installation of the front frame with the possibility of horizontal and depth alignment

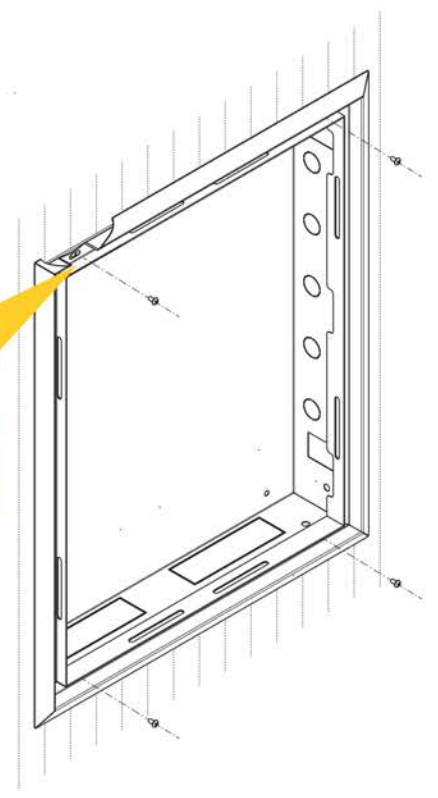
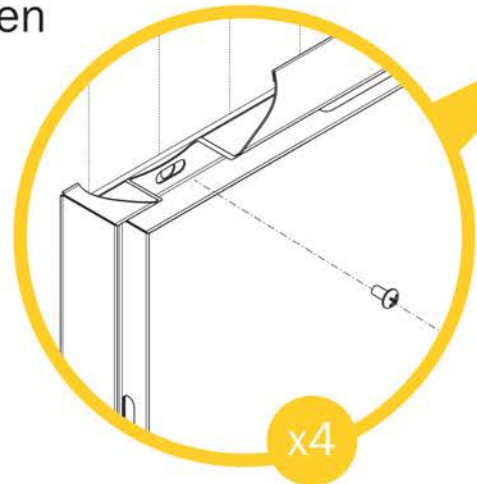

8

Габаритные размеры в миллиметрах Overall dimensions in mm

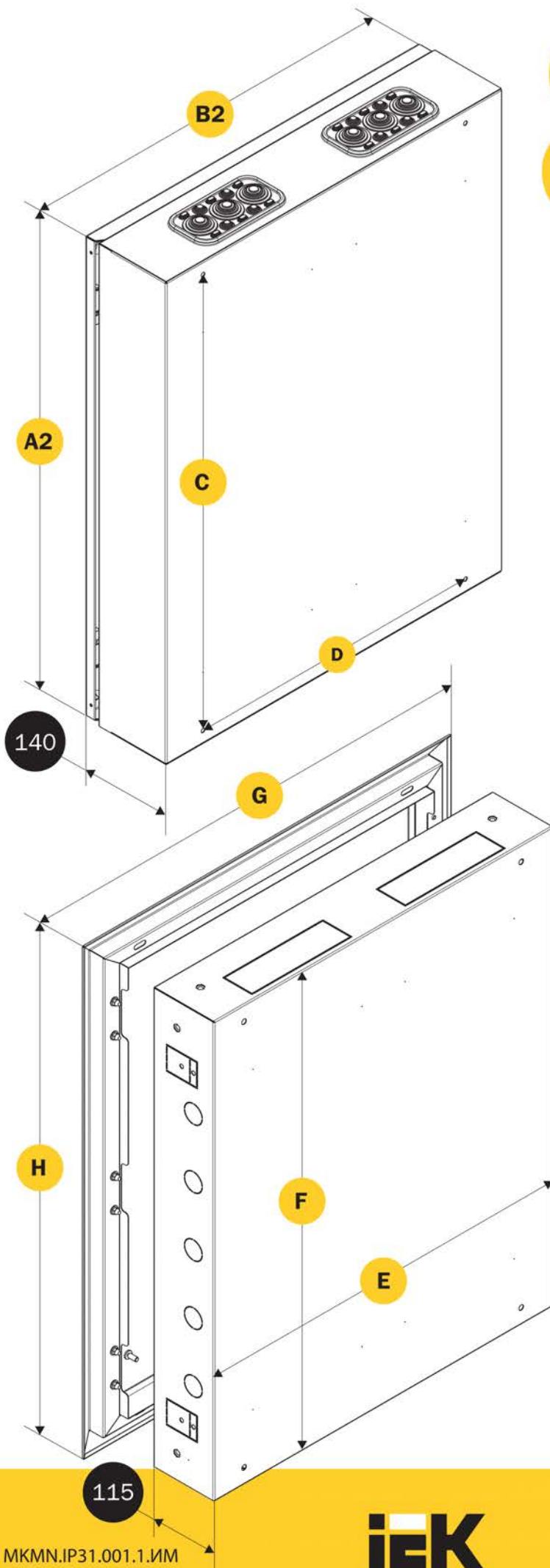

		A2	B2	C	D
ЩРН / wall mounted	12 (1x12)	335	310	295	185
	24 (1x24)	460	310	420	185
	36 (1x36)	585	310	545	185
	48 (1x48)	710	310	670	185
	60 (1x60)	835	310	795	185
	72 (1x72)	960	310	920	185
	84 (1x84)	1085	310	1045	185
	140 (1x140)	1400	310	1400	185
ЩРВ / flush-mounted	48 (2x24)	460	570	420	445
	72 (2x36)	585	570	545	445
	96 (2x48)	710	570	670	445
	120 (2x60)	835	570	795	445
	144 (2x72)	960	570	920	445
	168 (2x84)	1085	570	1045	445
	180 (3x60)	835	830	795	705
	216 (3x72)	960	830	920	705

		H	G	F	E
ЩРН / wall mounted	12 (1x12)	380	365	330	315
	24 (1x24)	505	365	455	315
	36 (1x36)	630	365	580	315
	48 (1x48)	755	365	705	315
	60 (1x60)	880	365	830	315
	72 (1x72)	1005	365	955	315
	84 (1x84)	1130	365	1080	315
	140 (1x140)	1400	365	1400	315
ЩРВ / flush-mounted	48 (2x24)	505	625	455	575
	72 (2x36)	630	625	580	575
	96 (2x48)	755	625	705	575
	120 (2x60)	880	625	830	575
	144 (2x72)	1005	625	955	575
	168 (2x84)	1130	625	1080	575
	108 (3x36)	630	885	580	835
	144 (3x48)	755	885	705	835
180 (3x60)	880	885	830	835	
216 (3x72)	1005	885	955	835	
252 (3x84)	1130	885	1080	835	