

| | | | | | |
|--------|----|----|--------|---------------------------------|---------------|
| | | | | 660 00/03 (NM) 660 01/04 (M) | 660 02/05 (S) |
| 660 00 | NM | 1h | 140 lm | | |
| 660 01 | M | 1h | 140 lm | | |
| 660 02 | S | 1h | 140 lm | | |
| 660 03 | NM | 3h | 110 lm | | |
| 660 04 | M | 3h | 110 lm | | |
| 660 05 | S | 3h | 110 lm | | |

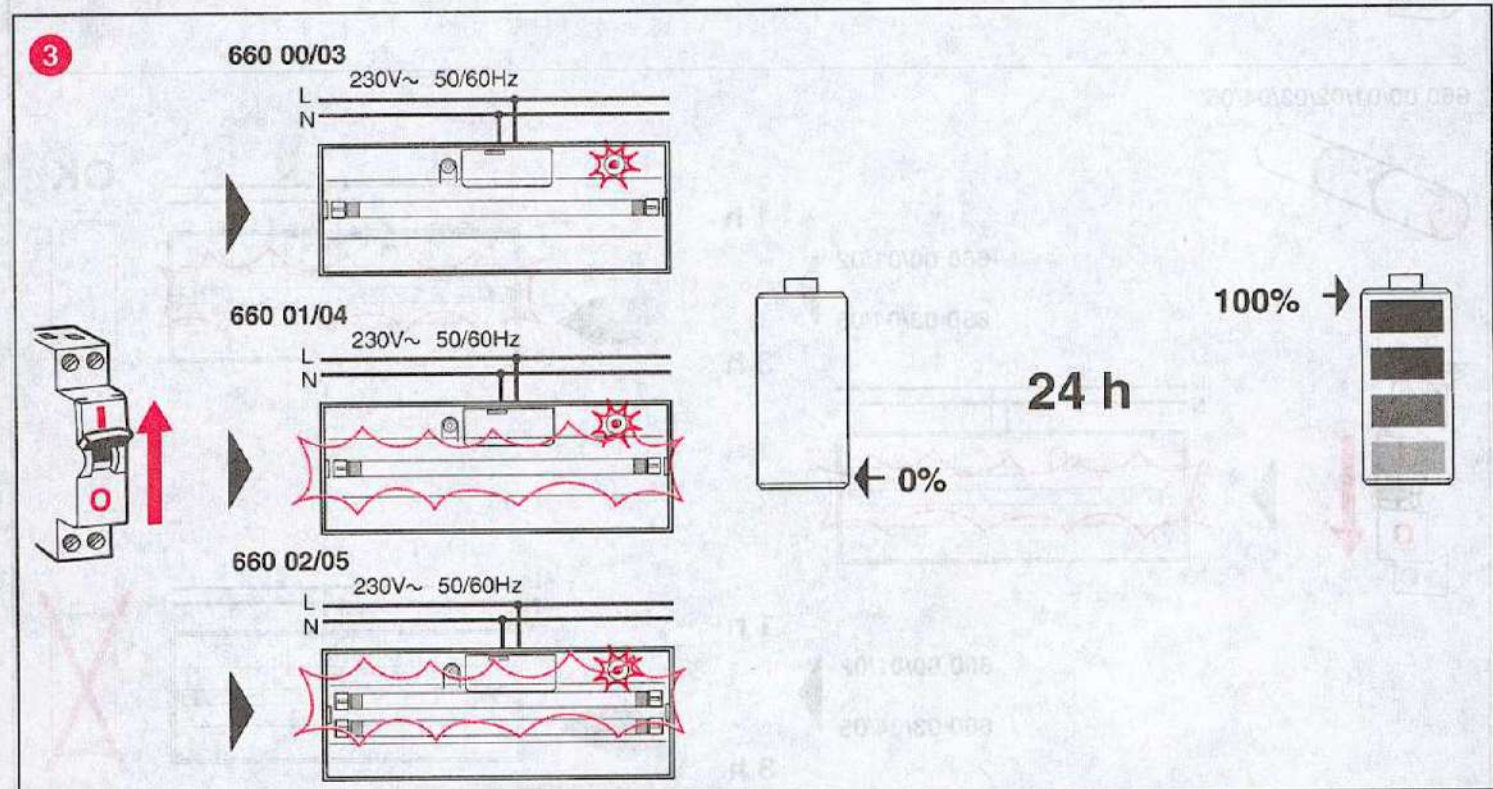
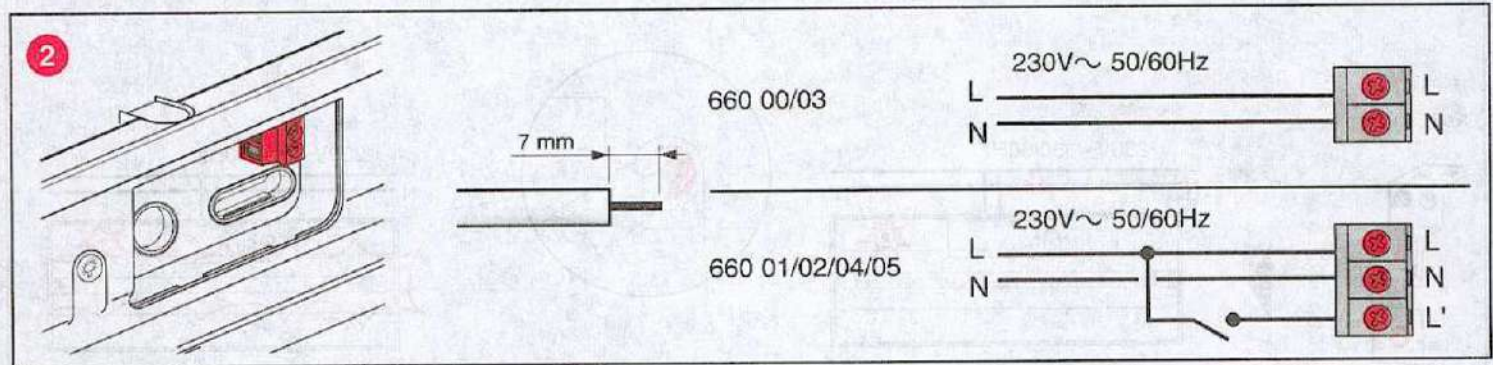
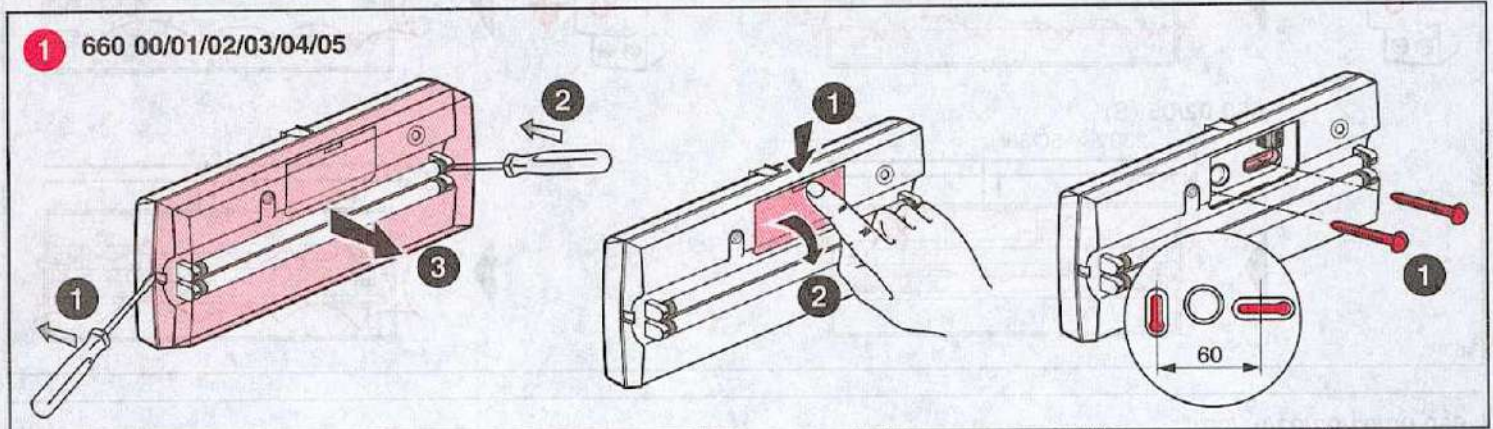

4

660 00/03 (NM)

230V~ 50/60Hz

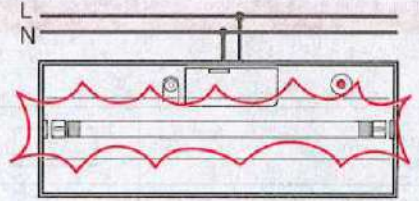
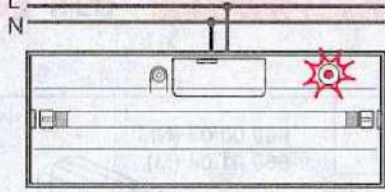

660 01/04 (M)

230V~ 50/60Hz

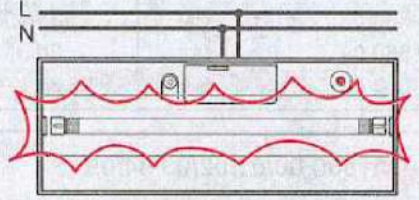
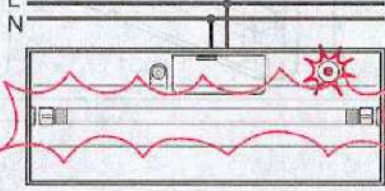

660 02/05 (S)

230V~ 50/60Hz

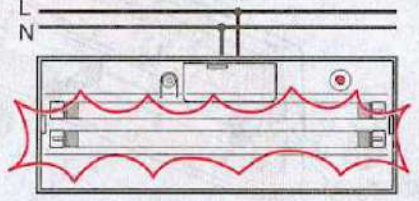
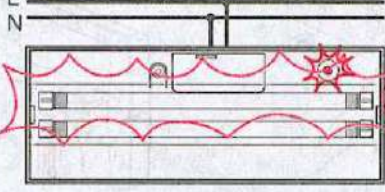

660 00/01/02/03/04/05

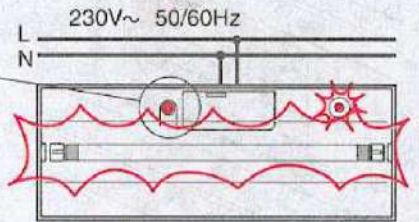
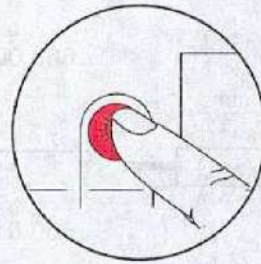
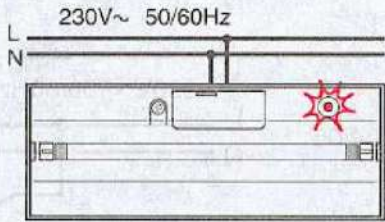

660 00/01/02/03/04/05

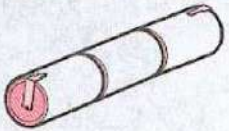

660 00/01/02

660 03/04/05

1 h

3 h

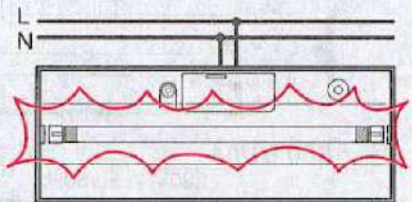
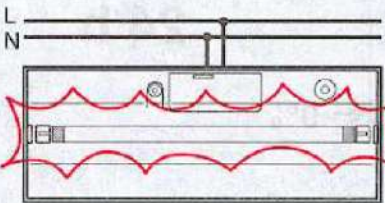

OK



660 00/01/02

660 03/04/05

1 h

3 h

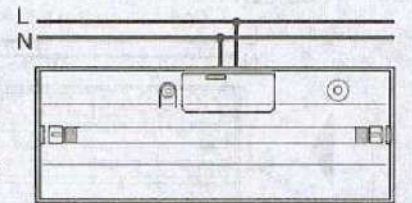
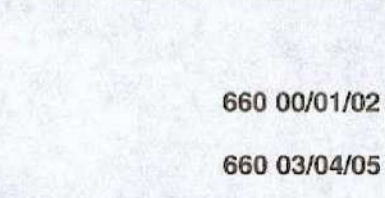

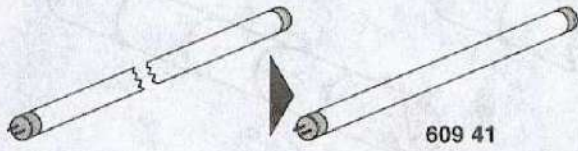

609 41

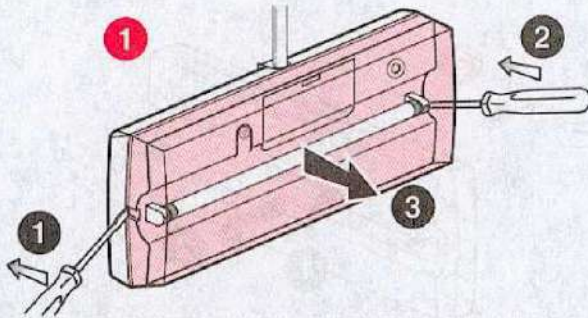

660 00/03 (NM)

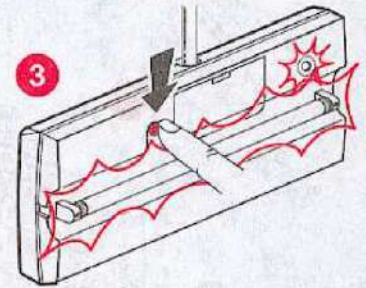
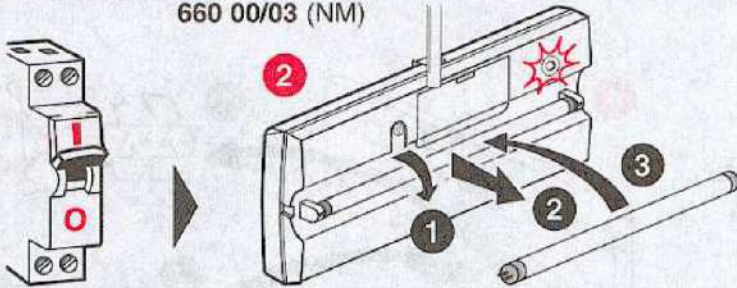

660 01/04 (M)

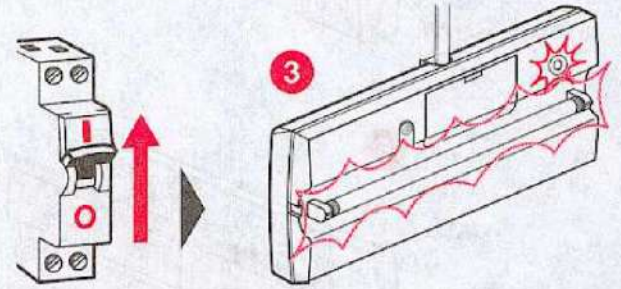
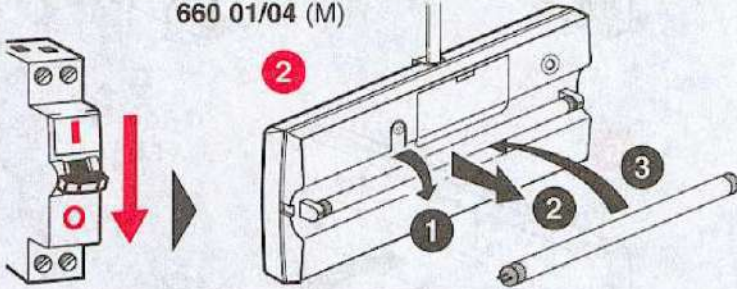

660 02/05 (S)

