

0°C ... +35°C	0°C ... +35°C	40 mm	10 / 13 mm 1...2,5...4 mm²

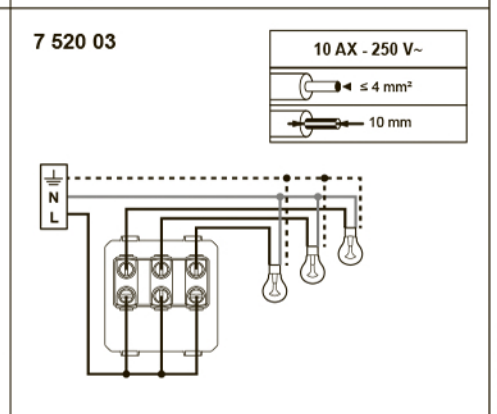

7 520 05

10 AX - 250 V~

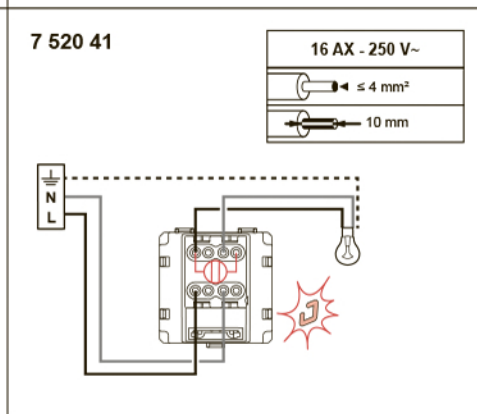
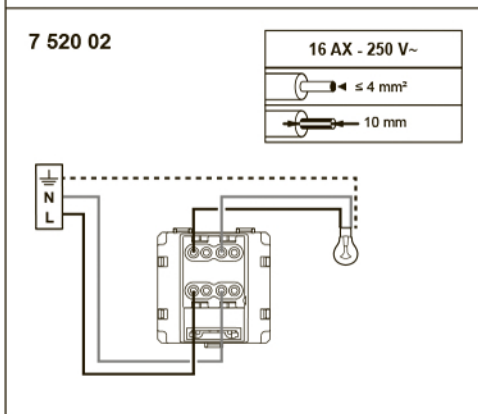
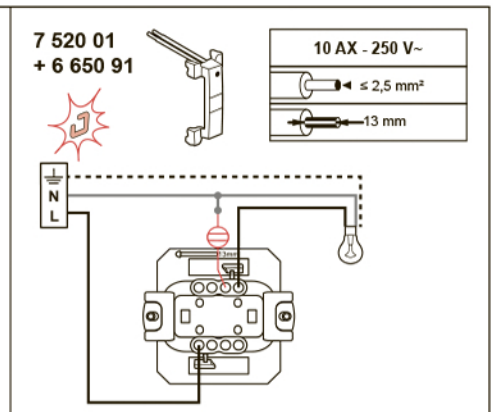
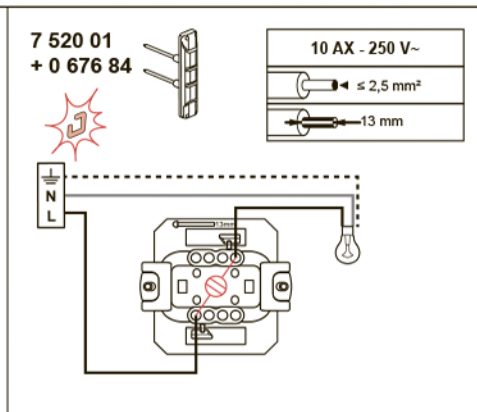
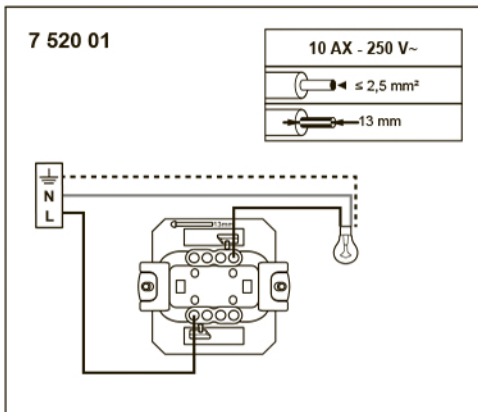
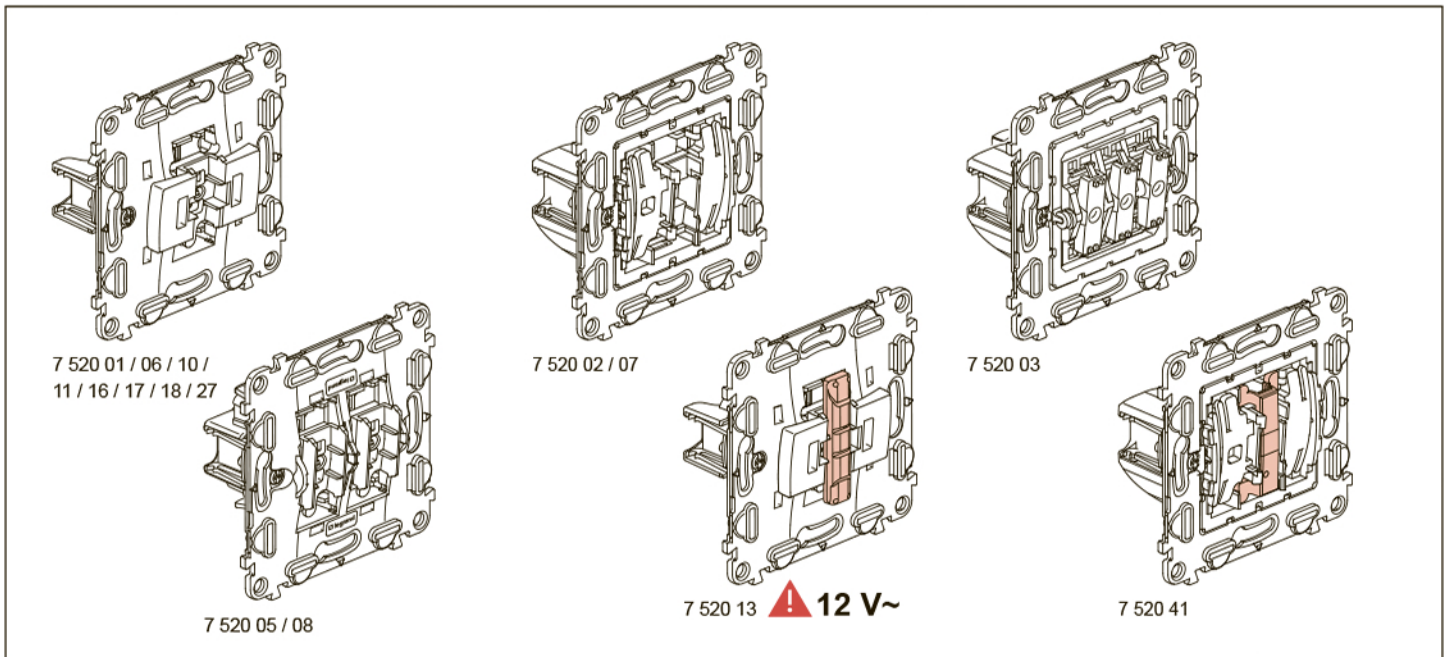
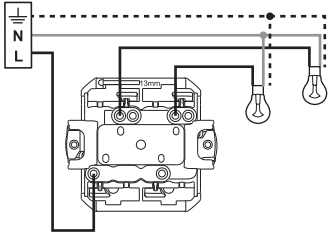
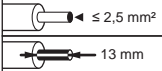

7 520 05
+ 0 676 84

10 AX - 250 V~

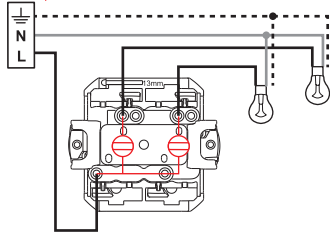
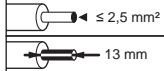

7 520 06 / 16

10 AX - 250 V~

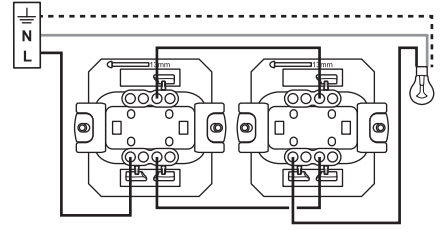
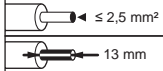

7 520 06 / 16
+ 0 676 86

10 AX - 250 V~

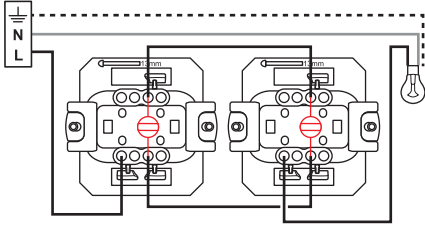
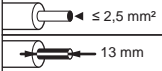

7 520 06 / 16
+ 7 520 57

10 AX - 250 V~

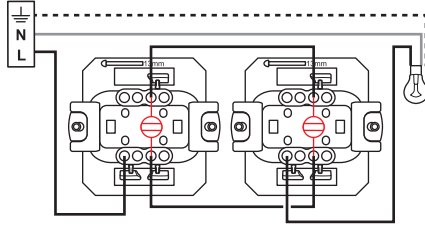
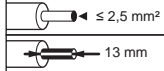

7 520 07

10 AX - 250 V~

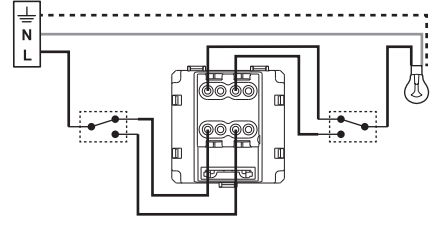
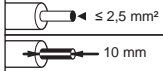

7 520 07
+ 6 650 90

10 AX - 250 V~

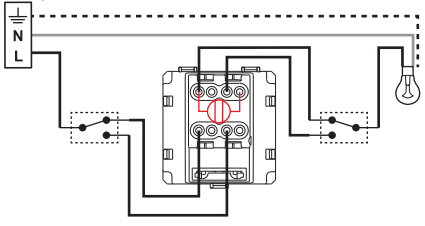
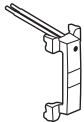
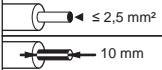

7 520 08 / 28

10 AX - 250 V~

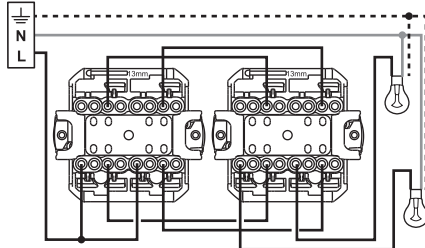
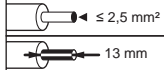

7 520 08 / 28
+ 0 676 86

10 AX - 250 V~

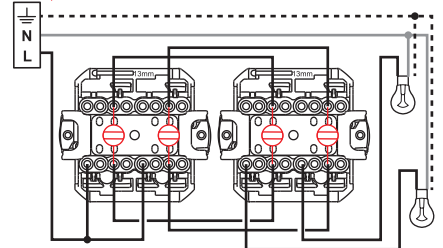
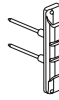
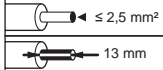

7 520 08 / 28
+ 7 520 57

10 AX - 250 V~

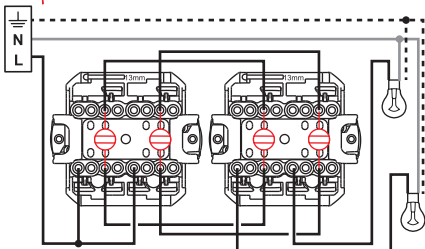
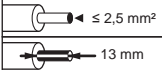

7 520 10

10 AX - 250 V~

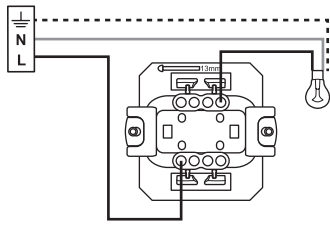
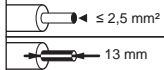

7 520 10
+ 0 676 88

10 AX - 250 V~

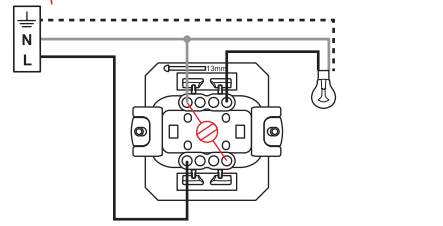
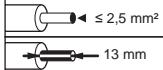

7 520 10
+ 7 520 58

10 AX - 250 V~

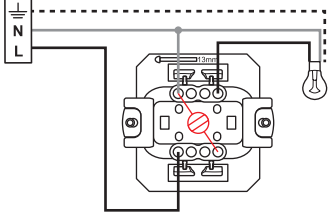
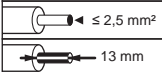

7 520 10

10 AX - 250 V~

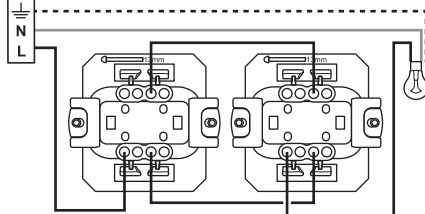
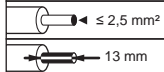

7 520 10
+ 0 676 86

10 AX - 250 V~

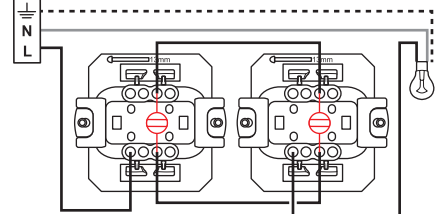
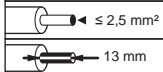

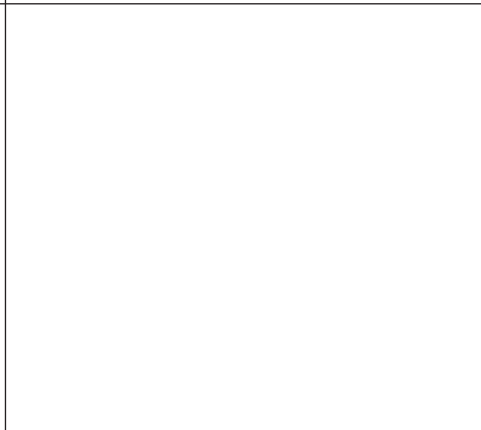
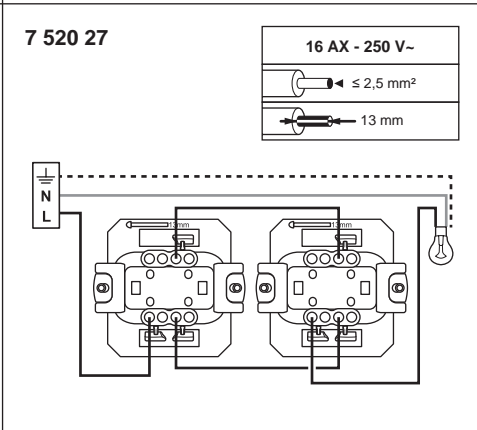
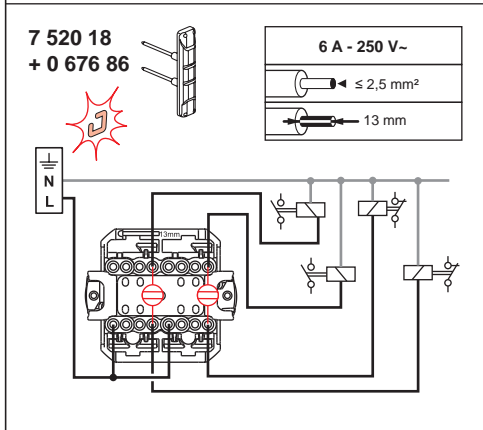
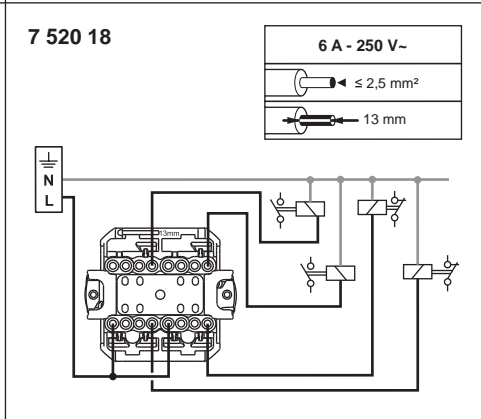
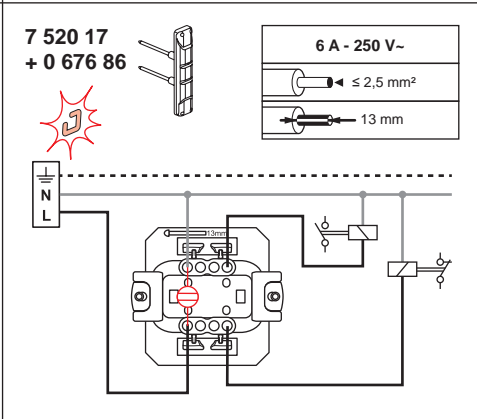
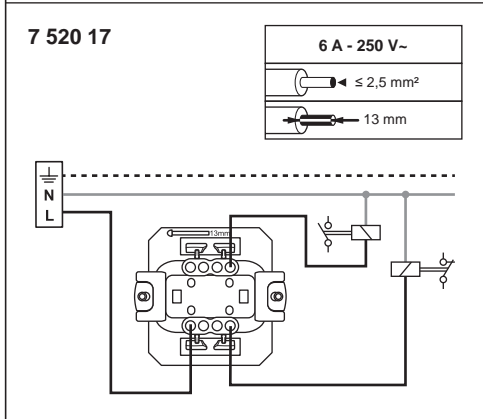
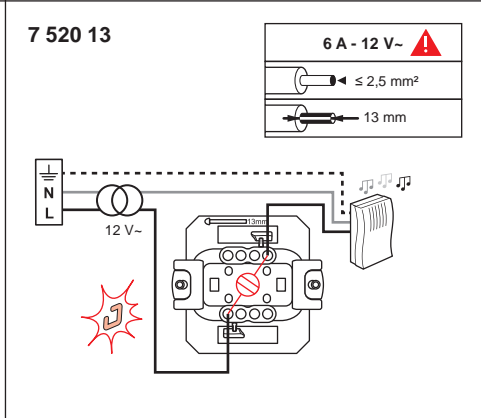
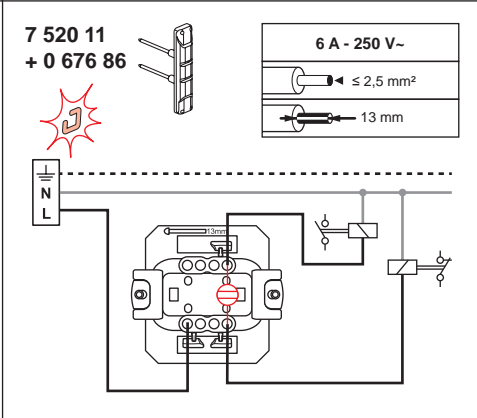
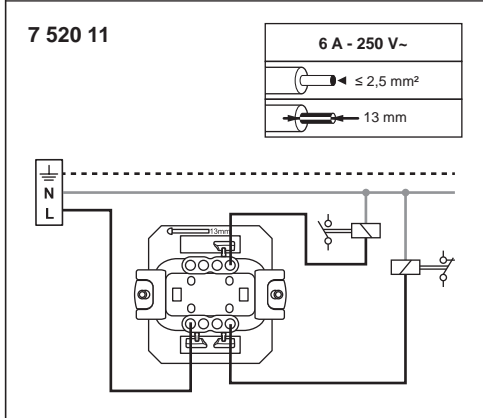
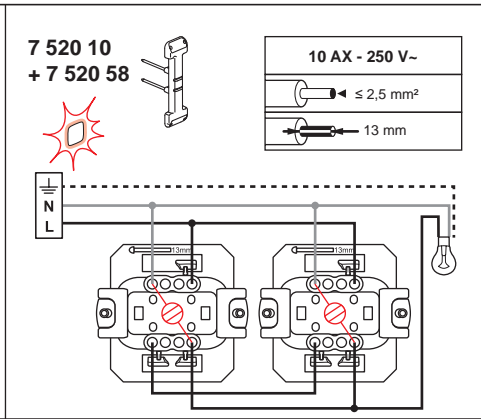
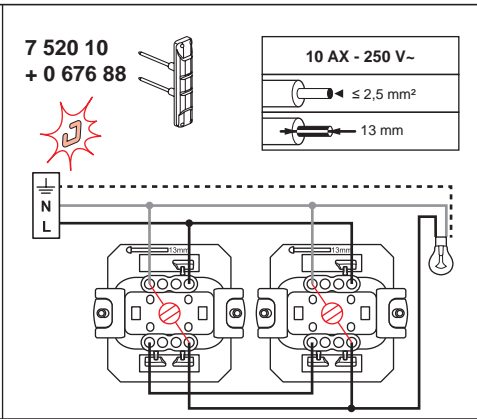
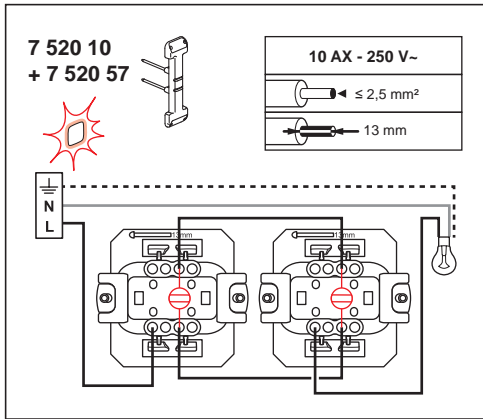



12 - 48 V~ ~~250 V~~~

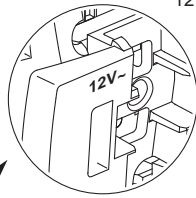
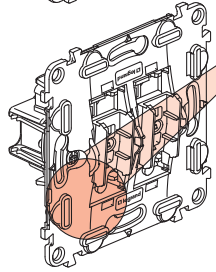
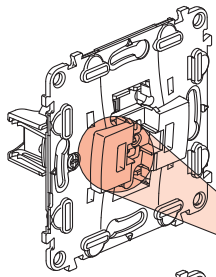

12 - 48 V~

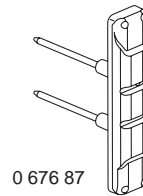

0 676 87

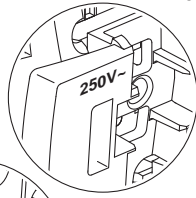

250 V~

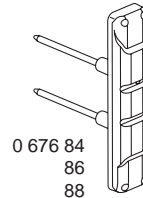

0 676 84
86
88

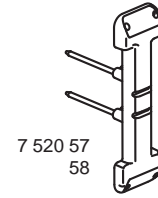

7 520 57
58

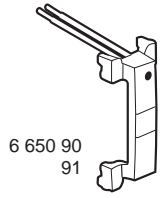

6 650 90
91

	0 676 84	0 676 86	0 676 87	0 676 88	6 650 90	6 650 91	7 520 57	7 520 58
7 520 01	✓	—	—	—	—	✓	—	—
7 520 02	—	—	—	—	—	—	—	—
7 520 03	—	—	—	—	—	—	—	—
7 520 05	✓	—	—	—	—	—	—	—
7 520 06 / 16	—	✓	—	—	—	—	✓	—
7 520 07	—	—	—	—	✓	—	—	—
7 520 08 / 28	—	✓	—	—	—	—	✓	—
7 520 10	—	✓	—	✓	—	—	✓	✓
7 520 11	—	✓	—	—	—	—	—	—
7 520 13	—	—	✓	—	—	—	—	—
7 520 17	—	✓	—	—	—	—	—	—
7 520 18	—	✓	—	—	—	—	—	—
7 520 27	—	—	—	—	—	—	—	—
7 520 41	—	—	—	—	—	✓	—	—