	660 00/03 (NM) 660 01/04 (M)	660 02/05 (S)
660 00	NM	1h	140 lm		
660 01	M	1h	140 lm		
660 02	S	1h	140 lm		
660 03	NM	3h	110 lm		
660 04	M	3h	110 lm		
660 05	S	3h	110 lm		

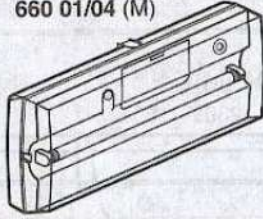

4

660 00/03 (NM)

230V~ 50/60Hz

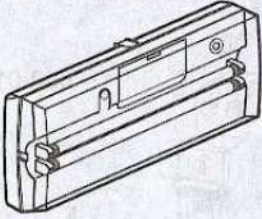
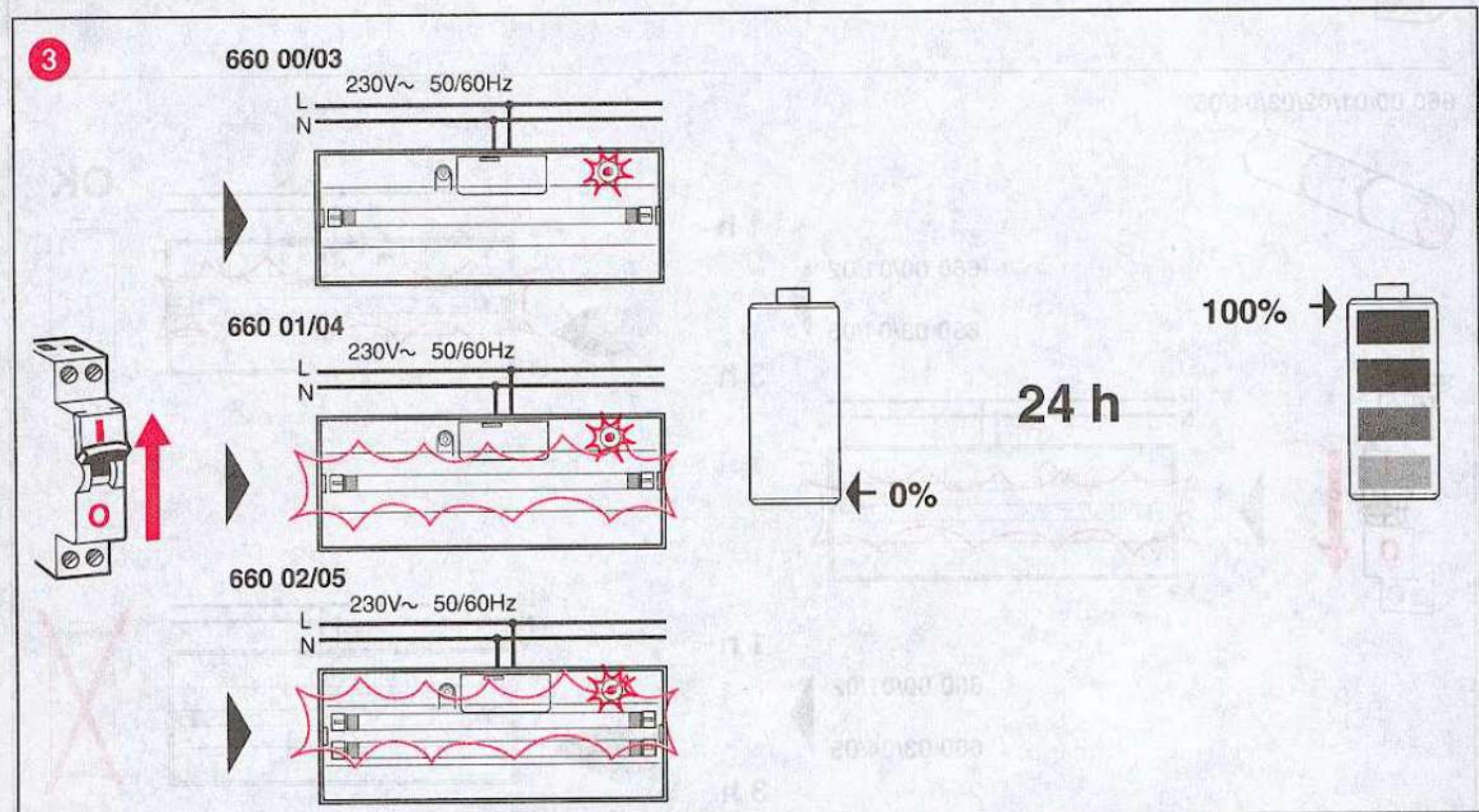
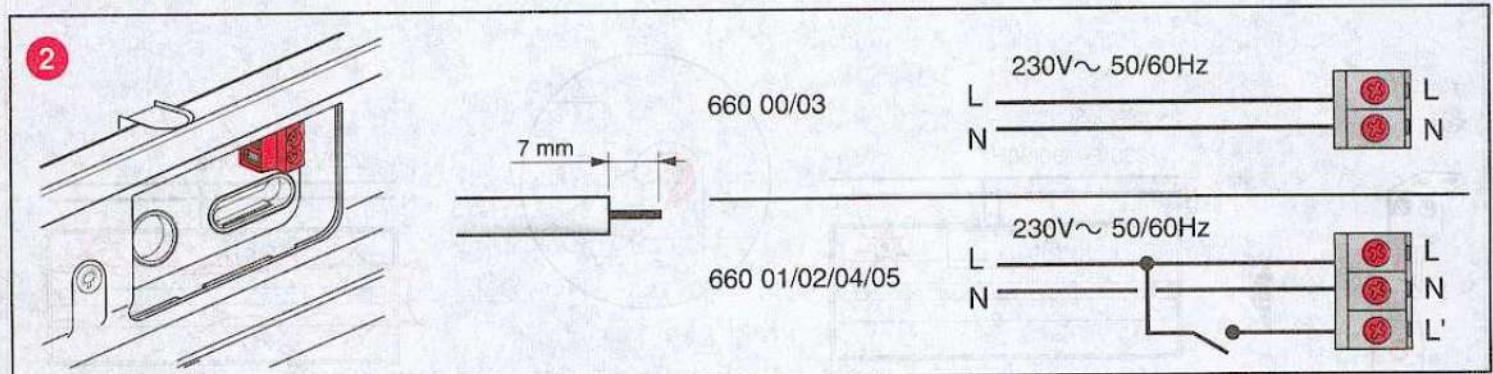
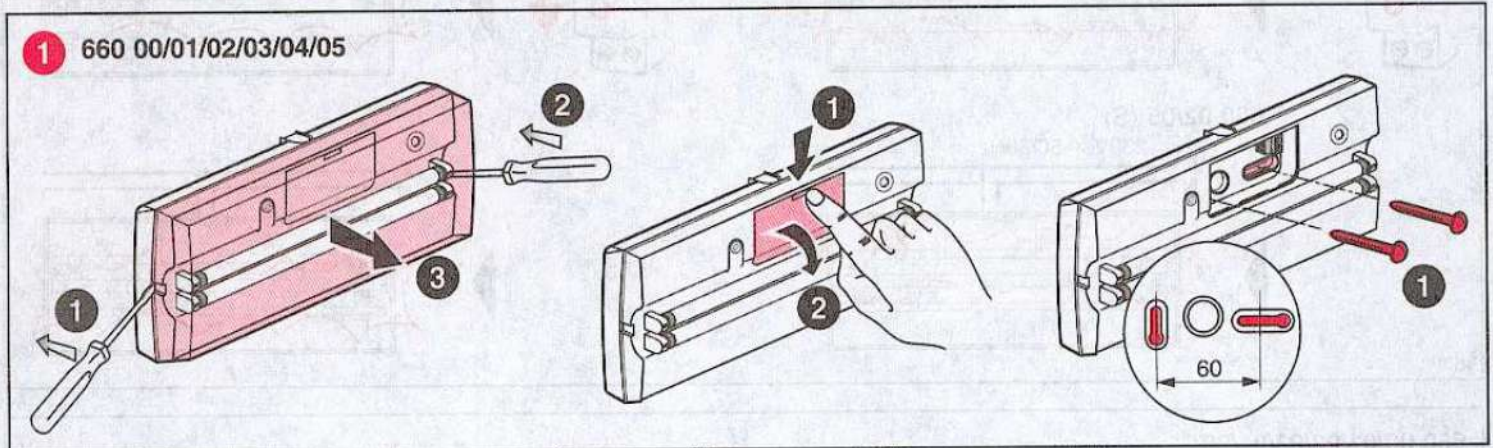
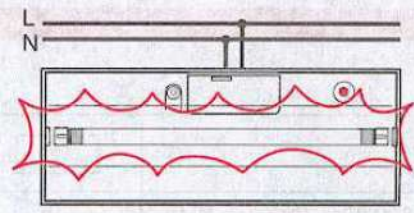
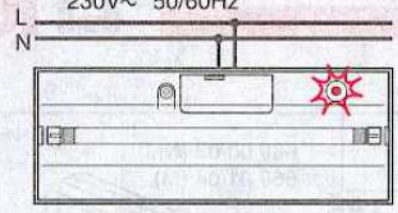

660 01/04 (M)

230V~ 50/60Hz

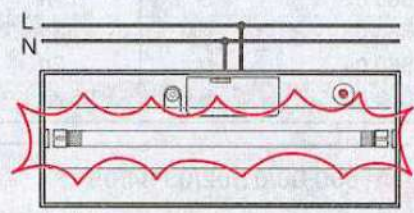
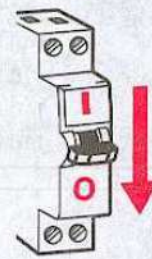
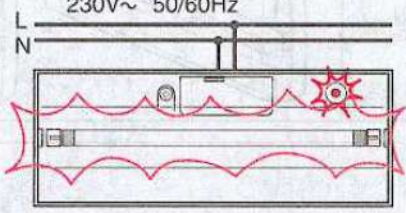

660 02/05 (S)

230V~ 50/60Hz

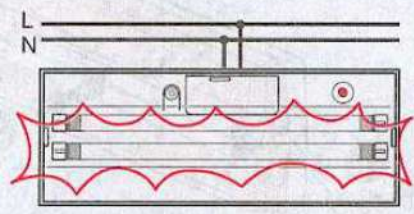
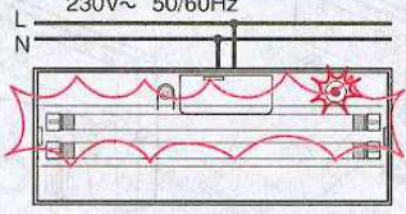

660 00/01/02/03/04/05

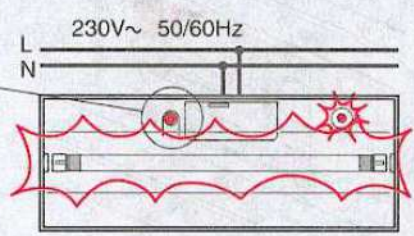
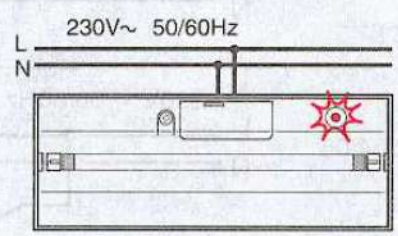
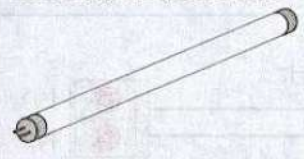

660 00/01/02/03/04/05

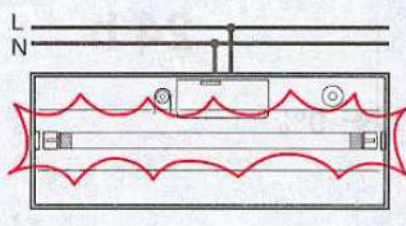
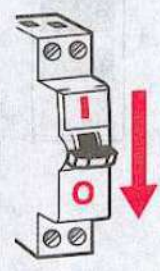
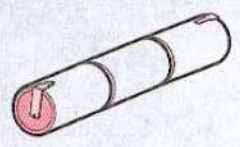

660 00/01/02

660 03/04/05

1 h

3 h

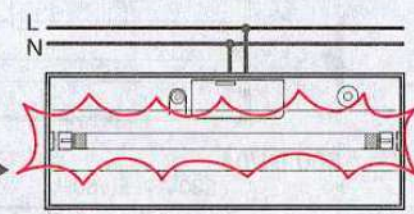

OK



660 00/01/02

660 03/04/05

1 h

3 h

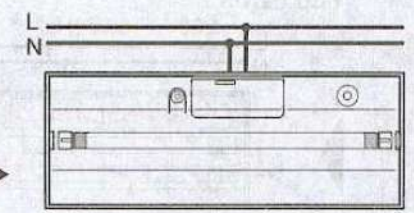

660 00/01/02/03/04/05

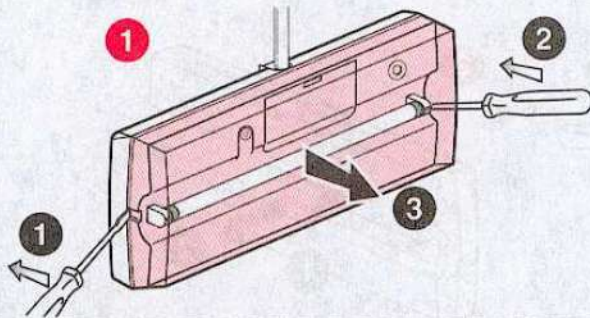
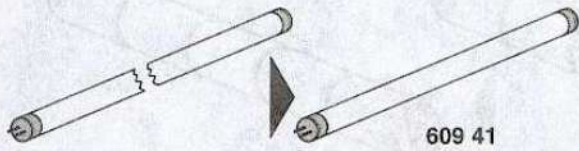

660 00/03 (NM)

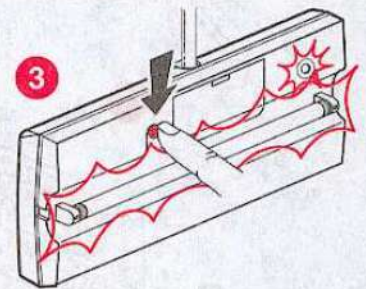
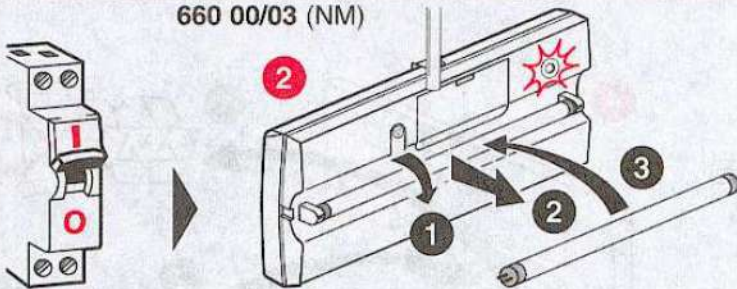

660 01/04 (M)

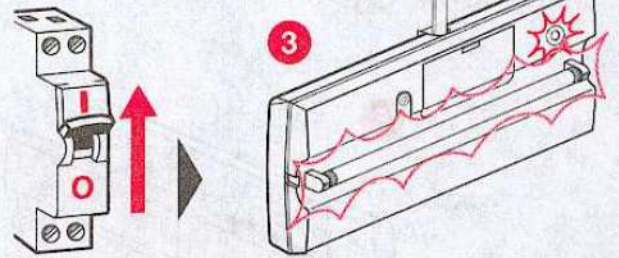
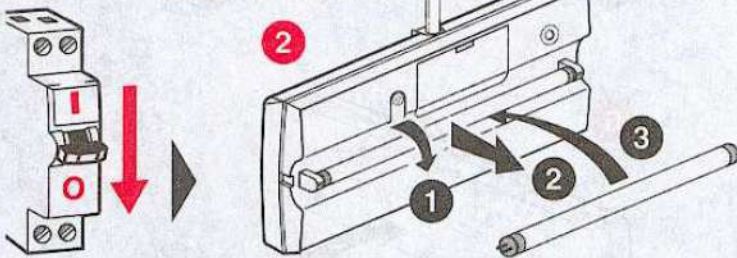

660 02/05 (S)

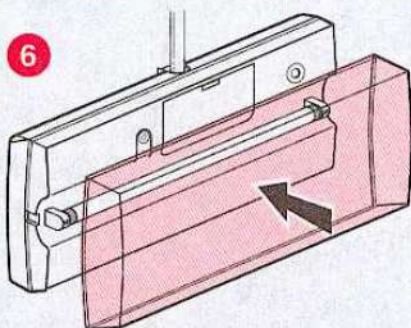
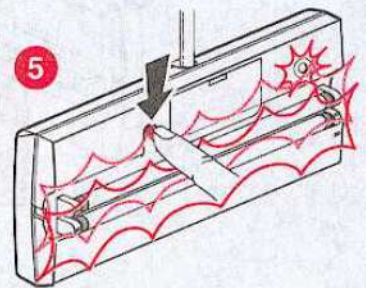
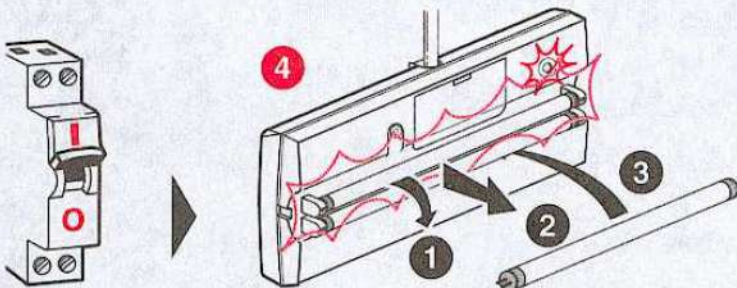
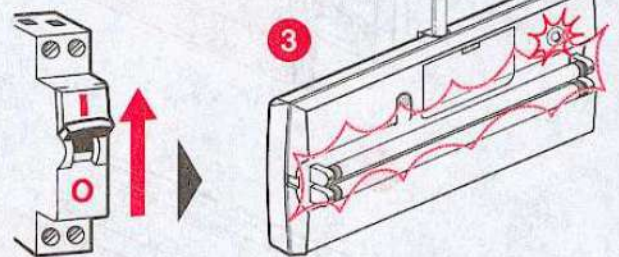
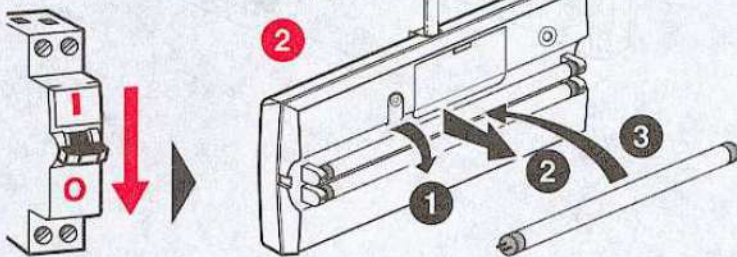

660 00/03 660 01/04 660 02/05

