

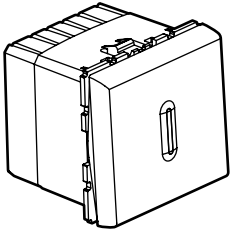













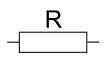
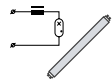
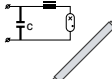

Mosaic™  
784 20

SHOP220

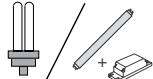
 **legrand®**

							
		1 ... 2,5 mm <sup>2</sup> 1 ... 2,5 mm <sup>2</sup>	- 5 ... + 50°C	- 10 ... + 60°C	40 mm 40 mm	<ul style="list-style-type: none"> <li>• &gt; 10 ans</li> <li>• &gt; 10 jaare</li> <li>• &gt; 10 years</li> <li>• &gt; 10 Jahre</li> <li>• &gt; 10 años</li> <li>• &gt; 10 лет</li> </ul>	25 s...15 min 25 с...15 мин
		1 ... 2,5 mm <sup>2</sup> 1 ... 2,5 mm <sup>2</sup>					

								
8A cos φ = 1 / 250V~ 8A cos φ = 1 / 250B~	1840W 1840Вт	400 VA 400ВА	2x 58W 14μF 2x 58Вт 14мкФ	1840W 1840Вт	400W 400Вт	250 VA 250ВА	400 VA 400ВА	400 VA 400ВА

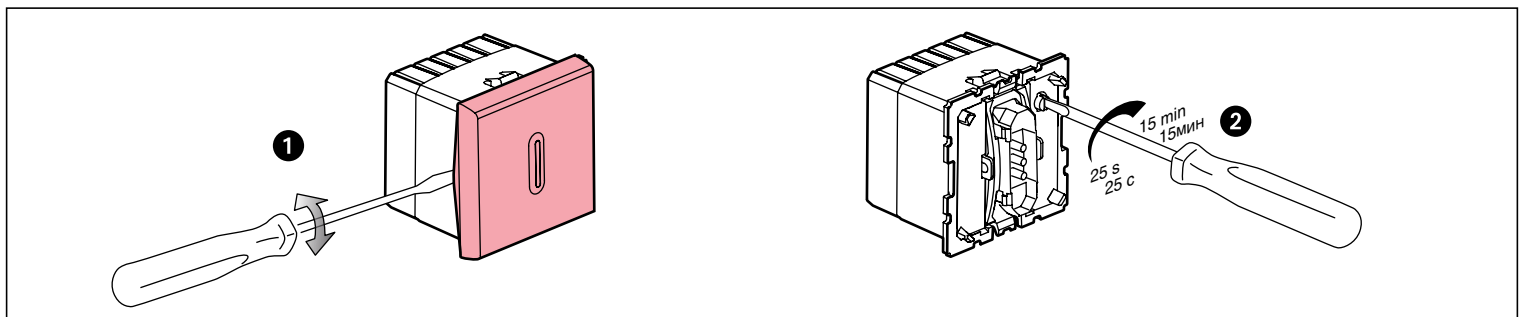

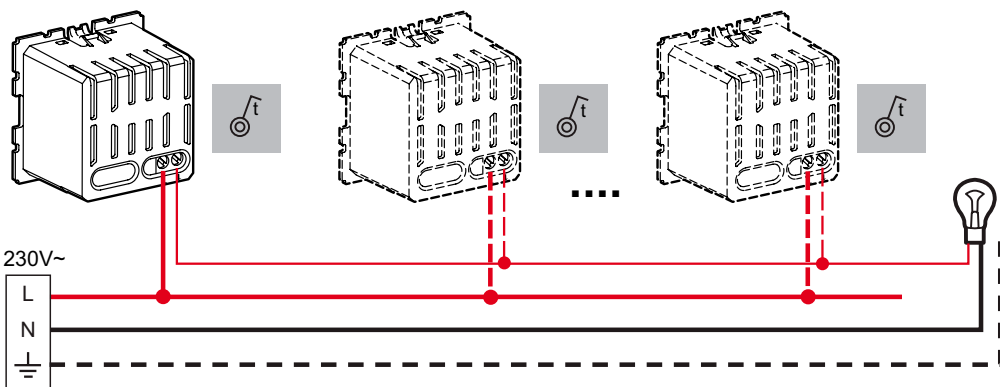

- Raccorder la tension de service avec la même phase.
- De apparaten moeten in fase worden aangesloten.
- The devices must be connected with the same phase relationships.
- Die Geräte müssen phasengleich angeschlossen werden.
- Los dispositivos têm que ser conectados com concordância de fases.
- Все соединенные аппараты установки должны быть подключены к одной цепи защиты.

